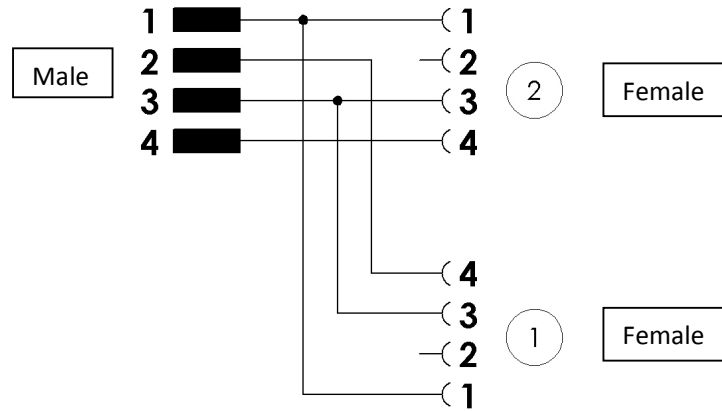

Technical Specification

	I/P End	O/P 1	O/P 2
Connector	M12, Male	M12, Female	M12, Female
Rated Voltage	250V	250V	250V
Coding	A	A	A
Number of pins	4	3	3
Current (at 40°C)	4A	4A	4A
Contact material	CuZn, Ni/Au (Gold Flash)	CuZn, Ni/Au (Gold Flash)	CuZn, Ni/Au (Gold Flash)
Contact carrier material	Nylon 66	Nylon 66	Nylon 66
Coupling nut material	CuZn, nickel plated	Zinc die-casted, nickel plated	Zinc die-casted, nickel plated

Insulation resistance	$\geq 10^8 \Omega$
Ambient temperature	-25°C...+85°C
Sealing material	Neoprene
Grip body material	TPU, Black
Shielding	No
Mechanical life-cycle	>100 mating cycles
Degree of protection	IP67
Degree of pollution	3
Standards	IEC 61076-2-101

Specifications are subject to change without notice.

Electrical connection



Specifications are subject to change without notice.



Type Approved
Safety
Regular Production
Surveillance



www.tuv.com
ID 1111210483